



INSTRUCTION MANUAL

M50 POC Trunked Mobile Radio

Kirisun Communications Co.,Ltd.

User Guide

M50

POC Trunked Mobile Radio

We are very grateful for your purchasing Kirisun brand POC mobile radio produced by Kirisun Communications Co., Ltd.

We believe Kirisun brand POC mobile radio, which always incorporates the latest technology, can bring great convenience to your life and work. We also believe that the quality and function of Kirisun two-way radio can meet your demands for reliable communication.

Notice to user

- ◆ Please read POC mobile radio's manual carefully before using the product, so that user can operate the machine more freely. When user use this product, we think you have read this manual.
- ◆ Please keep the POC mobile radio's manual for reference for future reference or users who use this product can read.
- ◆ In order to protect your legal rights and interests are inviolable, please fill in the "User Warranty Card" and purchase the true and valid proof of purchase when purchasing our products.
- ◆ All parts of this product, including accessories, etc., and its related intellectual property rights and other related to the Company or authorized by the Company owned by all, without the permission of the right subject, may not be arbitrarily copied, copied, extracted or translated.
- ◆ As the product involves upgrading or improvement, the company reserves the right to change the specifications of the software and hardware described in this manual at any time without prior notice. The product specifications and information mentioned in this manual are for reference only.

- ◆ Although all the texts are carefully checked, it is inevitable that there is a mistake and the company reserves all rights of final explanation.

Safety instructions

The government bans on operation the radio transmitter without permission in the jurisdiction scope. Illegal operation will punished with fine or arrest. This product can only be maintained by the professional technicians.

Safety:

It's very important for users to realize the generally dangerous of using the radio.

Warning:

Please turn off the radio when you are refueling in the explosive atmosphere (such as gas, dust and smog, etc.) or park at the gas station.

Notice

Please observe the following precautions to prevent fire, personal injury and radio damages

- ◆ Recommended radio usage is 1 minute for launching and 4 minutes for reception. Long-term launching or continuous using in high-power mode will cause the back of the machine to generate heat.
- ◆ Do not disassemble this unit under any circumstances.
- ◆ Do not expose the radio station to direct sunlight for long time, and never place it near a heating unit.
- ◆ Do not place the radio on areas that are extremely dusty, damp or splashing, and do not place it on an unstable surface.
- ◆ If abnormal odor or smoke is found from the radio, cut off the power immediately. Then contact your local dealer.

Contents

1	Unpacking and Checking	7
1.1	Supplied Accessories	7
2	The Device	10
2.1	Appearance Description	10
2.2	Device Installation	12
2.3	Programmable Buttons	14
2.4	LED Indicator Status.....	15
2.5	LCD Icon Status.....	17
3	Basic Function and Operation	19
3.1	Powering On/Off the Radio.....	19
3.2	Standby.....	19

3.3	Adjust the volume	19
3.4	Selecting a Channel	19
3.5	Making a Call	20
3.6	Receive the call	20
3.7	Delay access to reply calls	20
3.8	Priority call	20
3.9	Call Types.....	20
3.10	Download history recording and playback.....	25
3.11	Location Information Report	25
3.12	Advanced Signaling Function	25
4	Technical Specifications	26
5	Trouble Shooting	28

1 Unpacking and Checking

Please carefully open the box, and check if the accessories listed below are contained in the package. For any missing or damaged item, please contact your local dealer for solution.

1.1 Supplied Accessories

No.	Material	Quantity
1	POC Mobile	1
2	Hand microphone	1
3	Fixed bracket, with four M5*16 tapping screws	1
4	Power Supply Cable	1
5	3G Main Antenna	1
6	GPS Antenna	1

No.	Material	Quantity
7	Magnetic hand microphone hanger, with three M2.6*10 tapping screws	1
8	Plastic handle screws, with matching flat washers, spring washers, plastic gaskets	2
9	Fuse	1
10	3M glue stick	1
11	Certificate of Approval	1
12	User Manual	1



POC Mobile



Hand Microphone

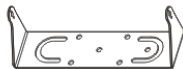

Fixed Bracket



Hand Microphone Hanger

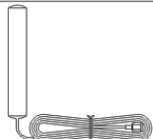

3G Main Antenna



GPS Antenna



Plastic Handle
Screws+Gaskets



M5*16+M2.6*10
tapping screws

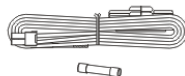

Power Supply Cable+Fuse

2 The Device

2.1 Appearance Description

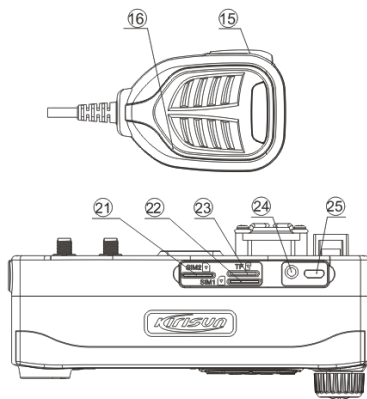
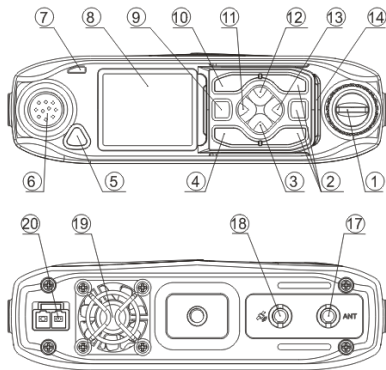

No.	Part Name	No.	Part Name
1	Volume Control Knob	14	Speaker
2	P1~P3(Programmable Keys)	15	PTT Key (Hand Microphone)
3	Down Key	16	Microphone
4	Return Button	17	Antenna Connector
5	Emergency Button	18	GPS Antenna Connector
6	Hand Microphone port	19	Cooling Fan
7	LED Indicator	20	Power Cable Connector
8	LCD Display Screen	21	SIM-2 Card Slot
9	On/Off Button	22	SIM-1 Card Slot

10	The Menu Button	23	TF Card Slot
11	Left key	24	Headphone port
12	Up Key	25	USB port
13	Right key		

2.2 Device Installation

Note:

- * Please consider whether it is convenient to use when choosing the location of the installation in the car and avoid vehicles in poor conditions when driving on the personnel harm; Please avoid damaging the vehicle and other equipment internal cables in the drilling installation.
- * The back of the car should be reserved enough space to facilitate cable connection.
- * Please keep the power cord enough slack in the car so that the radio can be easily disassembled and repaired while the power is connected.
- * Please make sure fuse meet the specific requirements when replacing a new one.

- 1) Please fix the mounting bracket in suitable place inside the vehicle with four M5*16 tapping screws.
- 2) Please use two plastic handle screws to secure the device to the mounting bracket
- 3) Connect the power cable

First arrange 3 meters power line and connect the open end to the engine battery or other power supply (Attention: the power supply voltage can not exceed 26V). Pay attention to the line color and connect red line to the positive pole then the black line connected to the negative pole.; Install the appropriate fuse supplied, and plug the end of the device into the rear power connector socket interface.

- 4) Please connect to the appropriate 3G main antenna and GPS antenna according to the logo on the back of the device

- 5) Install hand microphone

Put the direction indicative plane of the hand microphone plug on the top and insert it into the microphone interface of the mobile. Then clockwise rotate the self-lock cover on the microphone plug until the self-lock cover against the card slot. At this moment, please press down a little bit and continue rotate in clockwise until it can't be rotated.

Uninstall hand microphone

Anticlockwise rotate the self-lock cover on the hand microphone until you can't be rotated, then pull the plug out.

Install Microphone Hanger Clip

Using three M2.6*10 tapping screw to install the microphone Hanger clip at the place where it is convenient for your use (the microphone and the microphone line should install at the place doesn't impact the safe drive), put the hand microphone hang on the microphone hanger.

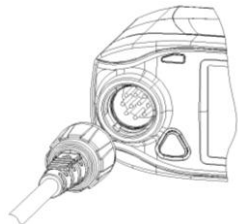

2.3 Programmable Buttons

For the convenience of users to operate the radio according to their own habits, the following buttons can be programmed as short cuts to radio functions by dealer.

P1 to P3 can be programmed to “long press” and “short press”.

Connect the data to the Micro USB external interface on the side of the device and program the mobile radio via programming software. By programming "P1", "P2" and "P3", the following functions are possible:

No.	Shortcut Keys	Description
1	None	No function. Press this button, mobile will be without any response.
2	Broadcast the user name	Broadcast mobile radio correspondent user name by voice
3	Broadcast group name	Broadcast mobile radio's current group name by voice
4	Download history recording and playback	On the condition that the platform open recording function, it can playback the last 5 recordings
5	Contact list	Display / broadcast contact information

2.4 LED Indicator Status



The LED indicator indicates the operational status of the device by changing color and flashing







LED Indicator Status	Mobile working status
Red light is always on	A、SIM card Not installed or SIM card installation error, voice prompt "failed to read the phone card" ; B、Not adding or configuring device on the business server ; C、Device added, channel select knob group mapping unsuccessfully ; D、SIM card's PIN unlock failed, voice prompt "PIN code error" ;
Green light is always on	A、Call (individual call / group call / all call) status B、Downloading / broadcasting history call recording
Yellow light is always on	A、Individual call standby status B、Duplex talk standby / call setup status
Red light is flashing fast	A、SIM card is not activated or arrears, the terminal can not register in the wireless network; B、Wireless network quality is poor, the terminal's can not register
Green light is flashing slowly	Registered successfully in network and standby;

Yellow light is flashing fast	In the "registering" status;
No instructions	In" idle" or "off" status

2.5 LCD Icon Status

When operating the device, different icons appear on the display to indicate its current status

Icon	Description
	2G / 3G signal receiving strength And Shows the strength of the receiving 2G / 3G signal.
E/3G	2G/3G signal "E" indicates 2G GPRS transmission; "3G" indicates 3G WCDMA transmission
	Wi-Fi signal strength. It Indicates the receiving Wi-Fi signal strength
	GPS search Display mobile radio in searching GPS satellite signal status

Icon	Description
	GPS signal lock It shows that the mobile has got the GPS signal
	Group call It shows device is in group call status
	Individual call It shows device is in Individual call status
	All call It shows device is in all call status
	Dispatcher It shows mobile radios under dispatcher dispatching status
	Battery capacity
	Message

3 Basic Function and Operation

3.1 Powering On/Off the Radio

In the power off status, long press the radio On-Off button  to power on the mobile.

The power on screen will be shown, backlight will light and the power on alert will be heard.

In the power on status, long press radio On-Off button  until power off screen is shown to power

3.2 Standby

After device successfully registered, the terminal turn into the standby state to minimize battery consumption.

3.3 Adjust the volume

Rotate the volume knob  clockwise to increase radio volume or counter-clockwise to decrease the volume.

3.4 Selecting a Channel

On standby status, press  or  key to select channel in the area.

3.5 Making a Call

When the current channel is a mapped channel (set in the management platform), directly press the PTT key to initiate a call to the current channel's default contact.

3.6 Receive the call

When the current channel is a mapped channel (set in the management platform), a call to this unit on that channel (individual call , group call) is received. Device will output the voice on this channel.

3.7 Delay access to reply calls

Allow the mobile to postpone for some time to access an ongoing group call.

3.8 Priority call

It supports different mobile radio's priorities settings. The high priority mobile radio can initiate call first..

3.9 Call Types

➤ Group call

After the terminal is powered on, it will turn into standby status of group call by default. At this time, the

terminal may be in an invalid group (Not configured, the red light is on) or a valid group (green light is flashing slowly)

1) Select a Call Group

In **【Channel group】** **【UP key】** / **【Down key】**  to select.

2) Make a group call:

Confirm the current status of the device is normal (green light is flashing slowly), press and hold **【PTT】** key: If there are other online users in the current group, the green light will be on., The current group name and the call type icon  are displayed on the LCD screen. And initiate the call. After the called user receives the call, the green light will remain on and the LCD screen will show the current group name, group type, current device name of initiating a group call. The call ends with a short "beep" sound, and the indicator light turn into green light flash slowly.

If there is no other online users in current group, the green light flashes and the LCD screen displays "no answer". Then release the [PTT] key, end the call, it will enter group call standby status.

➤ Individual Call

1) Set contact list

Set the "contact " of device in management platform.

2) Enter Individual Call mode:

Operate the pre-programmed [Individual Call] button (side button or top button, see "programmable button" part-2), enter Individual Call mode

3) Select an Individual Call receiver

Press the left key to select an individual call receiver in "Contact".

4) Make an Individual Call

After selecting an individual call receiver, confirm that the current device's status is normal (green light is flashing slowly), press the [PTT] key.

When the receiver is online and idle, the green light is always on. the name of the receiver and call type are displayed on the LCD screen ;After the receiver receives the call, the green light is always on and the name of the calling user are displayed on the LCD screen. After finished, both the indicator lights turns green and flash slowly and the receiver ends the call with a short "beep" sound.

When the called receiver is offline or busy, the green light flashes and the LCD screen shows "no answer", release the [PTT] key to end the call, the LCD screen will get back to previous status

After the calling finished, device of calling directly returns to previous status. If the receiver presses the [PTT] key again within 5 seconds, it can make individual call and talk again. Otherwise, without any operation, the device of receiver will automatically exit after 5 seconds and returns to the status before calling.

Note:

Individual Call priority is higher than Group call, it can go across groups, regardless of the called user in any group

System has a certain limited Individual Call talking time (40 seconds by default, it can be modified through the configuration tool), if the call is not ended within limited talking time, the system will automatically stop calling and prevent the call from a long time occupying.

➤ All call

All call is the highest priority call. When all call occurs, all the current calls (group call / individual call / duplex call) can be forcibly removed to make an all call.

1) Select all call group:

If the current device is configured with the all-call group on the management platform, select it through the **【Channel Group】** knob.

2) Make an All Call:

After selecting all call groups, confirm the current device's status is normal (green light is flashing slowly), press and hold [PTT] key: If the current enterprise users are online (no matter if is in idle, individual call, group call or duplex call status), then it can make an all call, the green light is always on, the current Group name and All Call status icon "" are displayed on the LCD screen. After the called user receives all call, the call status is changed to all call regardless of the online status, and the LCD

display shows the current group name, group type, and name of all call's Initiator, the green light remains on. After finished, it will have a short "beep" sound, and the light turns green and flash slowly.

If the current enterprise users are offline, the green light flashes, the LCD screen shows "no answer", release the [PTT] key, end the call, enter the all call standby status.

After each call finished, if there is no user (caller or receiver) making a call within 30 seconds, the device of called user will exits All Call to get back automatically and returns to the status before, and the caller remains in the all call status until leaving all call Group (via menu operation or rotate【Channel Group】 knob.

If the caller leaves all call groups actively (no matter whether it is in all call standby or calling mode), all receivers also automatically exit the all call and return to the status before the all-call. It can be seen on LCD screen's group type's variety.

Note:

All Call Mode right is recommended and configured to specific users only.

System has a certain limited all call talking time (30 seconds by default, it can be modified through the configuration tool), if the call is not ended within limited talking time, the system will automatically stop calling and prevent the call from a long time occupying.

3.10 Download history recording and playback

After the management platform opens the recording and playback function, operating the pre-programmed [Historical Recording Download and Playback] button (P1, P2, P3) and can download and play back the latest five recordings.

3.11 Location Information Report

Device's GPS module can be positioned and reported to the management platform, management platform / dispatcher can display radio's real-time position on the GIS map / historical trajectory.

Support connecting management platform and other radios via Wi-Fi network.

Wi-Fi network parameters can be set by programming software.

Support establishing Wi-Fi hotspots for other devices to access.

3.12 Advanced Signaling Function

Support remote dizzy, dead shot, wake up, and environmental monitoring and other functions.

4 Technical Specifications

General	
Communication Mode & Frequency Bands	WCDMA: 850MHz+900MHz +1900MHz+2100MHz GSM: 850M+900M+1800M+1900MHz WIFI & Bluetooth: 2.4GHz
Channel frequency interval	2G: 200kHz; 3G: 5MHz (Follow 2G / 3G protocol, managed and Configured by the telecom carrier)
Operating Temperature	-20℃ ~ + 50℃
Storage Temperature	-40℃ ~ + 80℃
Transmitter	
RF Power Output	2G: 32dBm +1dBm/-3dBm;; 3G: 22dBm +1dBm/-3dBm;
Frequency Stability	±0.1 ppm
Audio Distortion	5% (typical)

Receiver	
Frequency Stability	± 0.1 ppm
Sensitivity	2G: BER < 0.001 when $\hat{I}_{or} = 1\mu V$ 3G: BER < 0.001 when $\hat{I}_{or} = 1\mu V$
Rated Audio Power	1W
Rated Audio Distortion	5% (typical)

5 Trouble Shooting

Fault	Reason	Solution
Unable to boot	Mobile tail power plug loose	Please make sure the power plug is tight.
	Battery voltage or supply voltage is less than 6V	Please make sure the supply voltage is greater than 6V.
	Fuse burned	Please replace the fuse, make sure the power is connected correctly after booting.
When receiving signals, the sound is small, intermittent or	Supply voltage is too low	The battery is fully charged then use the mobile, or replace the power supply of which voltage is above 10.8V
	The volume is small	Turn up the volume.

Fault	Reason	Solution
silent	The antenna is loose or not installed	Please reset the antenna after turning off the device.
	The speaker is clogged or damaged	Please do simple cleaning outside. If still can't solve the issue, contact the dealer or our authorized maintenance center.
Cannot talk	Platform parameter settings	A, channel parameter setting is incorrect: re-set the parameters and try again; B, the default group identity of calling is incorrect: Please select the correct receiver and try again.
GPS cannot locate	The location is not good to receive the GPS signals	Please drive to places where receiving signal is good and try again.



Kirisun Communications Co.,Ltd.
<http://en.kirisun.com>

